

705nm~710nm 10mW Single Mode Coaxial Pigtailed Laser Diode with SMF | Built-in PD
705nm 10mW SM Fiber Coupled LD with Single Mode Fiber (SM Fiber) |4um SMF | With Photodiode
WSLP-705-010m-4-PD
Wavespectrum Laser Group
www.wavespectrum-laser.com

705nm Pigtailed Diode Laser		10mW/SM Fiber		Wavespectrum Laser Group	
PARAMETER	SYMBOL	VALUE		UNIT	
Reverse Voltage	V_r	2.0		V	
Operating Temperature	T_{op}	-10~+60		°C	
Storage Temperature	T_{stg}	-40~+85		°C	
Lead soldering temperature (10 sec.)	T_{is}	260		°C	
Features: <ul style="list-style-type: none"> 🔸 705nm 🔸 With SM Fiber 🔸 Coaxial or B82 Package 🔸 Built-in PD 					
Applications: <ul style="list-style-type: none"> 🔸 Medical Laser Treatment 🔸 Others 					
Specifications	WSLP-705-010m-4-PD				
	Min	Type	Max		
Center Wavelength@25°C	705nm±10nm				
Recommended Operating Temperature	25°C				
Output Power	----	10mW	----		
Fiber Type	Single Mode Fiber				
Fiber Core	4um				
Monitor Current	----	0.3mA	----		
PD Reverse Voltage	----	----	30V		
Fiber Connector	FC/SC/SMA905				
Fiber Length	>80cm				
Threshold Current (Typ.)	----	25mA	60mA		
Operating Current (Typ.)	----	70mA	80mA		
Operating Voltage	----	2.4V	3.0V		
Package Style	Coaxial or B82				
Photodiodes	Built-in				

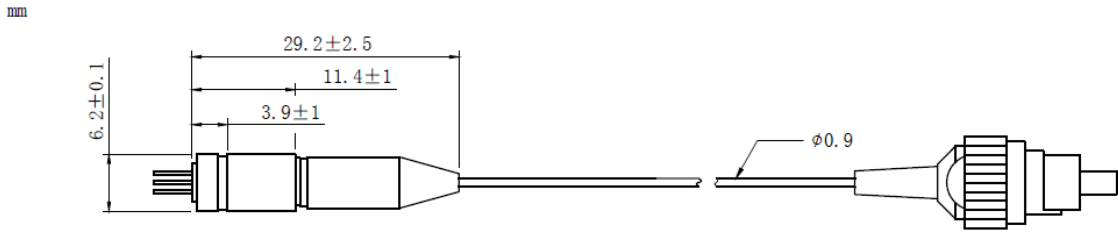
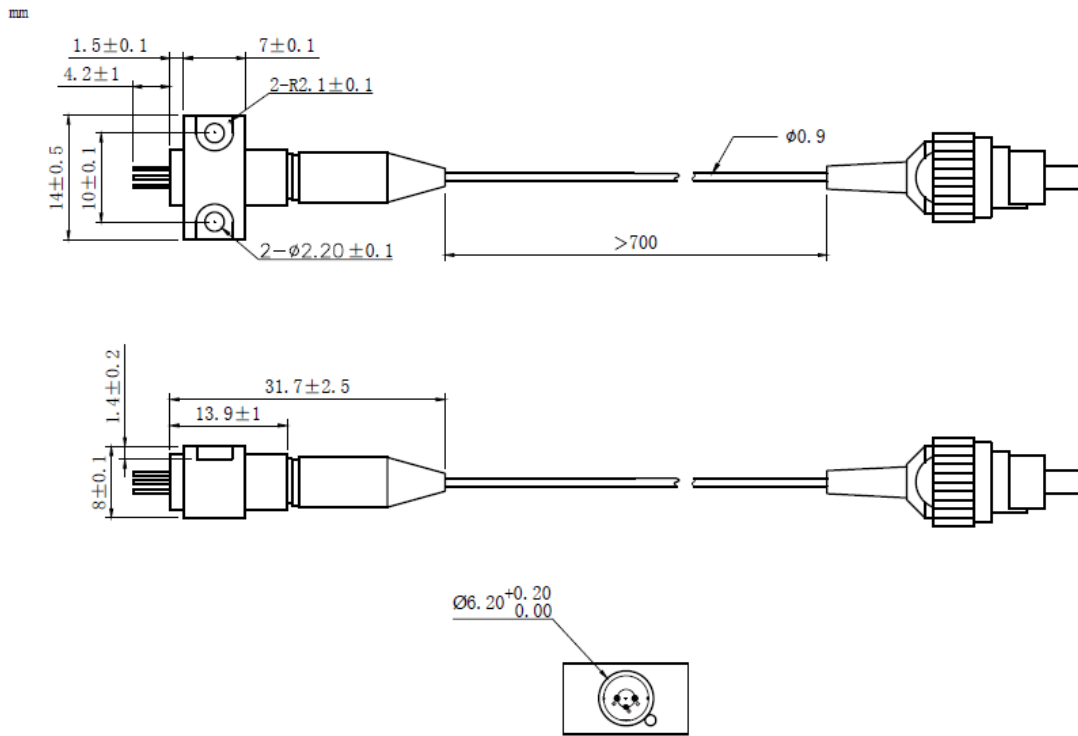
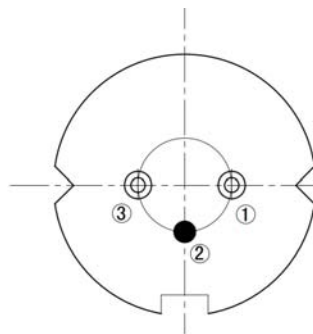

Coaxial Package View: (Part Number: WSLP-705-010m-4-PD)

B82 Package View: (Part Number: WSLP-705-010m-4-B-PD)

PIN Bottom View:

1	LD(-)
2	LD(+)& PD(-)
3	PD(+)



Electrically shorten LD module and store in non-extreme conditions.
Suggest using the constant current power supply.

