

660nm 1W High Power Laser Diode| C-mount Package| High Power Red LD| FAC Optional

658nm~660nm 1W C-mount Diode Laser | Red Laser Diodes

WSLD-660-001-C

Wavespectrum Laser Group

en.wavespectrum-laser.com.cn

660nm Laser Diode		1W/C-mount		Wavespectrum Laser Group	
PARAMETER	SYMBOL	VALUE		UNIT	
Reverse Voltage	V_r	2.0		V	
Operating Temperature	T_{op}	+10~+30		°C	
Storage Temperature	T_{stg}	-20~ +80		°C	
Lead soldering temperature (10 sec.)	T_{is}	260		°C	
Features: <ul style="list-style-type: none"> 660nm High Power ,CW, Multi-mode High Quality C-mount Package 					
Applications: <ul style="list-style-type: none"> Medical Laser Treatment Laser Indicator Laser Detector 					
Specifications		WSLD-660-001-C			
		Min	Type	Max	
Center Wavelength@25°C		660nm ± 10nm			
Spectral Width (FWHM)			2nm		
Output Power			1W		
Emitter Area			100x1μm		
Beam Divergence (FWHM)			35° _⊥ x 8° _{//}		
Temperature Coefficient of Wavelength			0.2nm / °C		
Slope Efficiency			1.1W/A		
Threshold Current (Typ.)			0.5A		
Operating Current (Typ.)			1.5A		
Operating Voltage			2.4V		
Package Style		C-mount			
Recommended Operation Temp		25°C			

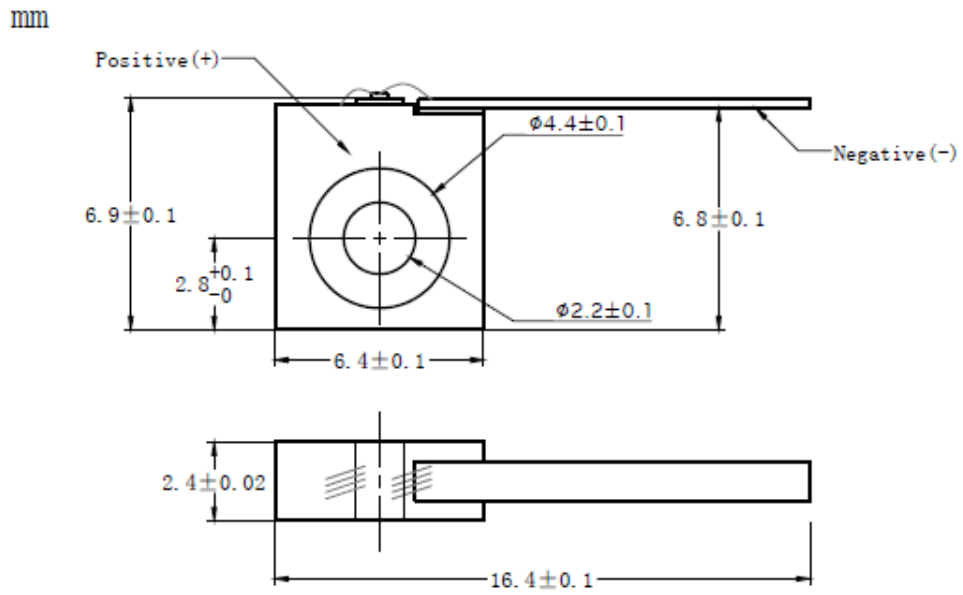

C-mount Package View:

**Electrically shorten LD module and store in non-extreme conditions.
 Suggest using the constant current power supply.**

