

658nm~660nm 5mW SM Coaxial Pigtailed Laser Diode with SMF | Built-in Photodiodes (PD)
660nm SM Fiber Coupled LD with Single Mode Fiber (SM Fiber) |With PD
WSLP-660-005m-4-PD
Wavespectrum Laser Group
www.wavespectrum-laser.com

660nm Pigtailed Diode Laser		5mW/SM Fiber		en.wavespectrum-laser.com.cn
PARAMETER	SYMBOL	VALUE	UNIT	
Reverse Voltage	V_r	2.0	V	
Operating Temperature	T_{op}	-10~+60	°C	
Storage Temperature	T_{stg}	-40~+85	°C	
Lead soldering temperature (10 sec.)	T_{is}	260	°C	
Features: <ul style="list-style-type: none"> ● 660nm ● 4um SM Fiber ● Coaxial or B82 Package ● Built-in PD 				
Applications: <ul style="list-style-type: none"> ● Medical Laser Treatment ● Others 				
Specifications	WSLP-660-005m-4-PD			
	Min	Type	Max	
Center Wavelength@25°C	660nm±10nm			
Recommend Operating Temperature	25°C			
Output Power	----	5mW	----	
Fiber Type	Single Mode Fiber			
Fiber Core	4um			
Monitor Current	----	0.3mA	----	
PD Reverse Voltage	----	----	30V	
Fiber Connector	FC/SC/SMA905			
Fiber Length	>80cm			
Threshold Current	----	35mA	55mA	
Operating Current	----	65mA	80mA	
Operating Voltage	----	2.4V	3.0V	
Package Style	Coaxial or B82			
Photodiodes	Built-in			

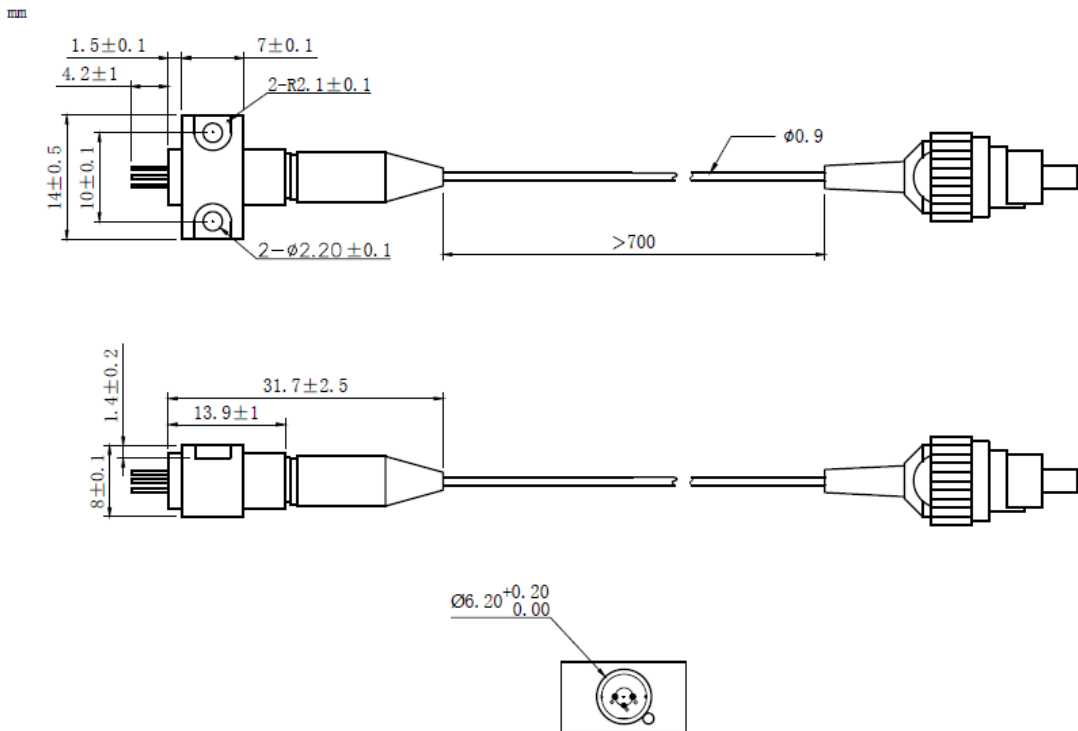
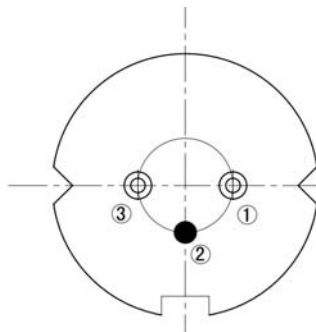

Coaxial Package View: (Part Number: WSLP-660-005m-4-PD)

B82 Package View: (Part Number: WSLP-660-005m-4-B-PD)

PIN Bottom View:

1	LD(-)
2	LD(+)&PD(-)
3	PD(+)



Electrically shorten LD module and store in non-extreme conditions.
Suggest using the constant current power supply.

