

830nm 200mW Single Mode Laser Diode

Features:

- 830nm
- Single Mode
- TO18 Package
- Built-in Photodiode

Applications:

- Medical Laser Treatment
- Biological Laser
- Others



WAVESPECTRUM offers high quality laser diodes, including single-mode laser diodes (SMLD) and multi-mode laser diodes (MMLD), according to different beam mode. To ensure high quality requirements of laser diodes, we adopt the world's top laser chips for making each laser diode, and the laser diodes will undergo severe aging and various testing before sending to the customer. At present, our company can provide laser diode products with the wavelength range of 405nm ~ 1920nm, and the optical power range is from 10mW to 15W. The main package includes TO38, TO18, TO5, TO3, C-mount, E-mount, COS and HHL window package. The PD backlight and TE Cooler is optional as per the customer's requirement.

WAVESPECTRUM can offer various wavelengths listed as below::







375nm, 405nm, 445nm/450nm, 465nm, 488nm, 505nm/510nm, 515nm/520nm/525nm, 633nm, 635nm/638nm/640nm/642nm, 650nm/658nm/660nm, 670nm, 685nm/690nm, 705nm, 730nm, 755nm/760nm/770nm, 780nm/785nm, 795nm, 800nm/808nm/810nm, 820nm/830nm, 840nm/850nm/860nm, 880nm, 905nm,915nm, 940nm, 976nm/980nm, 1060nm/1064nm, 1210nm, 1270nm, 1280nm, 1290nm, 1310nm, 1330nm, 1350nm, 1370nm, 1390nm, 1410nm, 1430nm, 1450nm, 1470nm, 1490nm, 1510nm, 1530nm, 1550nm, 1570nm, 1590nm, 1610nm, 1625nm, 1650nm, 1720nm, 1900nm, 1920nm.

WAVESPECTRUM can provide a variety of laser products: single mode laser diode, multimode laser diode, single mode fiber coupling laser modules, polarization maintaining fiber coupled laser modules, multi-mode pigtailed laser modules, fiber detachable laser module, RGB white fiber coupled laser module, medical laser module, turnkey fiber coupled laser system, etc. The main packages for the lasers can be: TO18 | TO5 | C-mount | TO3 | E-mount | H-mount | COS | 2-pin | 4-pin | 9-pin |14-pin.

WAVESPECTRUM - welcome to to inquiry any time!

Pls visit our Website for more info.: <http://wavespectrum-laser.com.cn/index.html>

MORE CHOICES, MORE IDEAS

																																	
Laser Diode			Fiber Coupled Laser Module				Fiber Receptacle LD				Laser System				RGB Pigtailed White Laser				Medical Laser Module														
375nm	405nm	445nm	465nm	488nm	505nm	520nm	525nm	635nm	650nm	660nm	670nm	680nm	685nm	760nm	785nm	790nm	808nm	830nm	850nm	860nm	880nm	905nm	915nm	940nm	980nm								
1064nm	1210nm	1270nm	1280nm	1290nm	1310nm	1330nm	1350nm	1370nm	1390nm	1410nm	1430nm	1450nm	1470nm	1490nm	1510nm	1530nm	1550nm	1570nm	1590nm	1610nm	1625nm	1650nm	1720nm	1900nm	1920nm								
														<p>WAVESPECTRUM LASER GROUP LIMITED Email: sales@wavespectrum-laser.com.cn Tel.: +86 22 8793 1118 Web.: http://en.wavespectrum-laser.com.cn</p>																			



830nm 200mW Single Mode Laser Diode

Part Number		WSLD-830-200m-1-PD		
PARAMETER		SYMBOL	VALUE	UNIT OF MEASURE
Reverse Voltage		V_r	2.0	V
Operating Temperature		T_{op}	-20~+50	°C
Storage Temperature		T_{stg}	-40~+85	°C
Lead Soldering Temperature (10 sec.)		T_{is}	260	°C
Typical Specification (@25°C)		Min.	Typical Value	Max.
Optical Specifications	Center Wavelength	830nm+/-15nm		
	Output Power	----	200mW	----
	Spectral Width(FWHM)	----	3.0nm	----
	Wavelength Temp. Coefficient	0.3nm/°C		
	Laser Type	FP		
	Beam Type	Single Mode		
	Beam Divergence(FWHM)	----	28° ⊥ x 8° //	----
	Slope Efficiency	----	1.0mW/mA	----
Electrical Specifications	Threshold Current	----	40mA	70mA
	Operating Current	----	260mA	280mA
	Operating Voltage	----	2.7V	3.2V
Photodiode Specifications	Photodiode	Built-in		
	PD Current	----	0.6mA	----
	PD Reverse Voltage (Max.)	25V		
Other Specifications	Package Style	TO18 (5.6mm)		
	Recommended Operating Temp.	25°C		

Product Package View:
TO18 (5.6mm) Package:

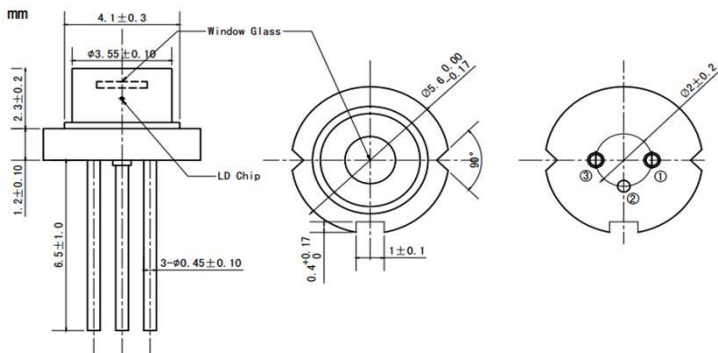

PIN Bottom View:

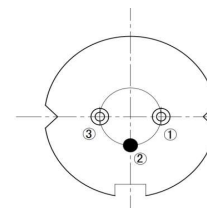

Pin-1	LD(-)
Pin-2	LD(+)&PD(-),CASE
Pin-3	PD(+)

