

785nm 100mW Single Mode Laser Diode

Features:

- 785nm
- Single Mode
- TO18 Package
- Built-in Photodiode

Applications:

- Medical Laser Treatment
- Biological Laser
- Others



WAVESPECTRUM offers high quality laser diodes, including single-mode laser diodes (SMLD) and multi-mode laser diodes (MMLD), according to different beam mode. To ensure high quality requirements of laser diodes, we adopt the world's top laser chips for making each laser diode, and the laser diodes will undergo severe aging and various testing before sending to the customer. At present, our company can provide laser diode products with the wavelength range of 405nm ~ 1920nm, and the optical power range is from 10mW to 15W. The main package includes TO38, TO18, TO5, TO3, C-mount, E-mount, COS and HHL window package. The PD backlight and TE Cooler is optional as per the customer's requirement.

WAVESPECTRUM can offer various wavelengths listed as below::







375nm, 405nm, 445nm/450nm, 465nm, 488nm, 505nm/510nm, 515nm/520nm/525nm, 633nm, 635nm/638nm/640nm/642nm, 650nm/658nm/660nm, 670nm, 685nm/690nm, 705nm, 730nm, 755nm/760nm/770nm, 780nm/785nm, 795nm, 800nm/808nm/810nm, 820nm/830nm, 840nm/850nm/860nm, 880nm, 905nm,915nm, 940nm, 976nm/980nm, 1060nm/1064nm, 1210nm, 1270nm, 1280nm, 1290nm, 1310nm, 1330nm, 1350nm, 1370nm, 1390nm, 1410nm, 1430nm, 1450nm, 1470nm, 1490nm, 1510nm, 1530nm, 1550nm, 1570nm, 1590nm, 1610nm, 1625nm, 1650nm, 1720nm, 1900nm, 1920nm.

WAVESPECTRUM can provide a variety of laser products: single mode laser diode, multimode laser diode, single mode fiber coupling laser modules, polarization maintaining fiber coupled laser modules, multi-mode pigtailed laser modules, fiber detachable laser module, RGB white fiber coupled laser module, medical laser module, turnkey fiber coupled laser system, etc. The main packages for the lasers can be: TO18 | TO5 | C-mount | TO3 | E-mount | H-mount | COS | 2-pin | 4-pin | 9-pin |14-pin.

WAVESPECTRUM - welcome to to inquiry any time!

Pls visit our Website for more info.: <http://wavespectrum-laser.com.cn/index.html>

MORE CHOICES, MORE IDEAS

|  | | | | | | | | | | | | | |  | | | |  | | | |  | | |  | | |  | |
|---|--------|----------------------------|--------|--------|--------|---------------------|--------|--------|--------|--------------|--------|--------|---------------------------|---|--------|----------------------|--------|---|--------|--------|--------|--|--------|--------|---|--|--|---|--|
| Laser Diode | | Fiber Coupled Laser Module | | | | Fiber Receptacle LD | | | | Laser System | | | RGB Pigtailed White Laser | | | Medical Laser Module | | | | | | | | | | | | | |
| 375nm | 405nm | 445nm | 465nm | 488nm | 505nm | 520nm | 525nm | 635nm | 650nm | 660nm | 670nm | 680nm | 685nm | 760nm | 785nm | 790nm | 808nm | 830nm | 850nm | 860nm | 880nm | 905nm | 915nm | 940nm | 980nm | | | | |
| 1064nm | 1210nm | 1270nm | 1280nm | 1290nm | 1310nm | 1330nm | 1350nm | 1370nm | 1390nm | 1410nm | 1430nm | 1450nm | 1470nm | 1490nm | 1510nm | 1530nm | 1550nm | 1570nm | 1590nm | 1610nm | 1625nm | 1650nm | 1720nm | 1900nm | 1920nm | | | | |



WAVESPECTRUM LASER GROUP LIMITED
 Email: sales@wavespectrum-laser.com.cn
 Tel.: +86 22 8793 1118
 Web.: <http://en.wavespectrum-laser.com.cn>



785nm 100mW Single Mode Laser Diode

| Part Number | | WSLD-785-100m-1-PD-R | | | |
|--------------------------------------|------------------------------|----------------------|-------------------|--------------------|--|
| PARAMETER | SYMBOL | VALUE | UNIT OF MEASURE | | |
| Reverse Voltage | V_r | 2.0 | V | | |
| Operating Temperature | T_{op} | -10~+60 | °C | | |
| Storage Temperature | T_{stg} | -40~+85 | °C | | |
| Lead Soldering Temperature (10 sec.) | T_{is} | 260 | °C | | |
| Typical Specification (@25°C) | | Min. | Typical Value | Max. | |
| Optical Specifications | Center Wavelength | 785nm+/-10nm | | | |
| | Output Power | ---- | 100mW | ---- | |
| | Spectral Width(FWHM) | ---- | 2.0nm | ---- | |
| | Wavelength Temp. Coefficient | 0.3nm/°C | | | |
| | Laser Type | FP | | | |
| | Beam Type | Single Mode | | | |
| | Beam Divergence(FWHM) | 15° \perp x8°// | 17° \perp x9°// | 19° \perp x10°// | |
| | Slope Efficiency | ---- | 1.1mW/mA | ---- | |
| Electrical Specifications | Threshold Current | ---- | 35mA | ---- | |
| | Operating Current | ---- | 125mA | ---- | |
| | Operating Voltage | ---- | 2.3V | ---- | |
| Photodiode Specifications | Photodiode | Built-in | | | |
| | PD Current | ---- | 0.3mA | ---- | |
| | PD Reverse Voltage (Max.) | 30V | | | |
| Other Specifications | Package Style | TO18 (5.6mm) | | | |
| | Recommended Operating Temp. | 25°C | | | |

Product Package View:
TO18 (5.6mm) Package:

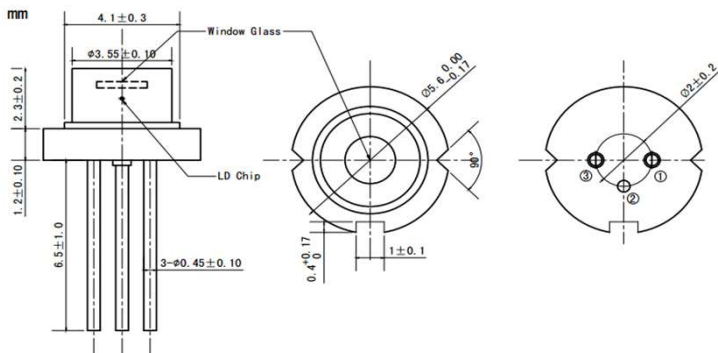

PIN Bottom View:

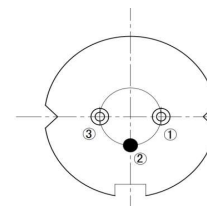

| | |
|-------|------------------|
| Pin-1 | LD(+) |
| Pin-2 | LD(-)&PD(+),CASE |
| Pin-3 | PD(-) |

