

808nm~810nm 40mW SM Pigtailed Laser diode with Coaxial Package | Built-in Photodiode
808nm 40mW SM Fiber Coupled LD with Single Mode Fiber (SM Fiber) | With PD
WSLP-808-040m-4-PD
Wavespectrum Laser Group
www.wavespectrum-laser.com

808nm Pigtailed Diode Laser		40mW/SM Fiber		en.wavespectrum-laser.com.cn
PARAMETER	SYMBOL	VALUE	UNIT	
Reverse Voltage	V_r	2.0	V	
Operating Temperature	T_{op}	-10~+50	°C	
Storage Temperature	T_{stg}	-40~+85	°C	
Lead soldering temperature (10 sec.)	T_{is}	260	°C	
Features: <ul style="list-style-type: none"> ● 808nm ● With SM Fiber ● B15 Package ● Built-in PD 				
Applications: <ul style="list-style-type: none"> ● Medical Laser Treatment ● Others 				
Specifications	WSLP-808-040m-4-PD			
	Min	Type	Max	
Center Wavelength@25°C	±5nm	808nm	±10nm	
Recommended Operating Temperature	25°C			
Output Power	----	40mW	----	
Fiber Type	Single Mode Fiber			
Fiber Core	5um			
Monitor Current	----	0.1mA	----	
PD Reverse Voltage	----	----	30V	
Fiber Connector	FC/SC/SMA905			
Fiber Length	----	80cm	100cm	
Threshold Current (Typ.)	----	30mA	60mA	
Operating Current (Typ.)	----	140mA	160mA	
Operating Voltage	----	2.2V	2.6V	
Package Style	B15			
PD	Built-in			

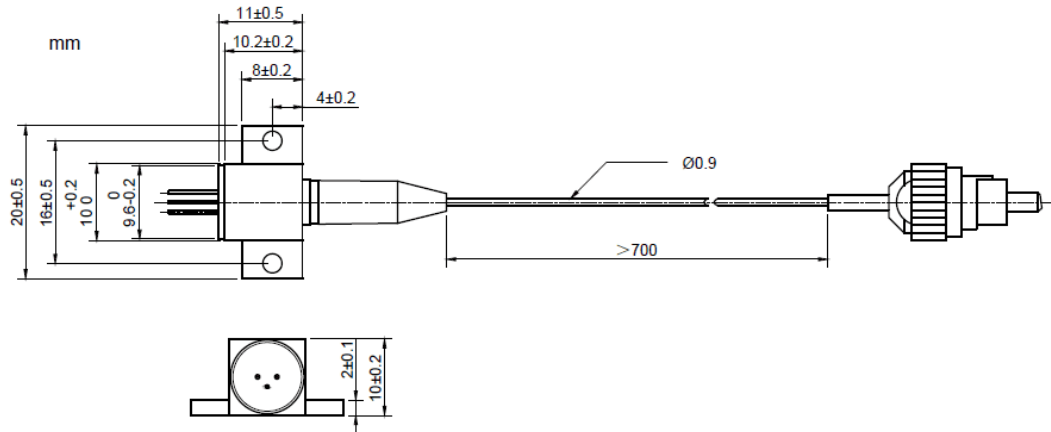
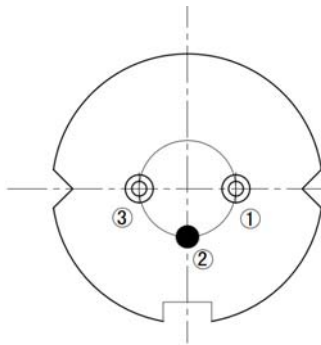

B15 Package View:

PIN Bottom View:

1	LD(-)
2	LD(+) & PD(-)
3	PD(+)

Electrically shorten LD module and store in non-extreme conditions.

Suggest using the constant current power supply.

