

685nm 15mW~20mW PM Fiber Coupled Laser Diode with Coaxial Package | Red Laser Diode
685nm~690nm 15mW Coaxial Pigtailed LD with Polarization Maintaining Fiber (SM Fiber)
 WSLP-685-015m-PM-PD Wavespectrum Laser Group www.wavespectrum-laser.com

685nm Pigtailed Diode Laser		15mW/PM Fiber		en.wavespectrum-laser.com.cn	
PARAMETER	SYMBOL	VALUE		UNIT	
Reverse Voltage	V_r	2.0		V	
Operating Temperature	T_{op}	-10~+60		°C	
Storage Temperature	T_{stg}	-40~+85		°C	
Lead soldering temperature (10 sec.)	T_{is}	260		°C	
Features: <ul style="list-style-type: none"> ● 685nm ● PM Fiber ● High Reliability ● High Polarization Extinction Ratio Applications: <ul style="list-style-type: none"> ● Biological Instruments ● Analytical Equipment ● Others 					
Specifications	WSLP-685-015m-PM-PD				
	Min	Type	Max		
Center Wavelength@25°C	±5nm	685nm	±15nm		
Recommended work Temperature	25°C				
Output Power	----	15mW	----		
Fiber Type	Polarization Maintaining Fiber				
Fiber Core	4um				
Polarization Extinction Ratio	13dB	15dB	----		
Monitor Current	----	0.3mA	----		
Fiber Connector	FC/APC				
Fiber Length	----	80cm	100cm		
Threshold Current (Typ.)	----	35mA	60mA		
Operating Current (Typ.)	----	100mA	120mA		
Operating Voltage	----	2.7V	3.0V		
Package Style	Coaxial or B82				
High Polarization Extinction Ratio (PER) Version Laser Module is also available, please contact us.					

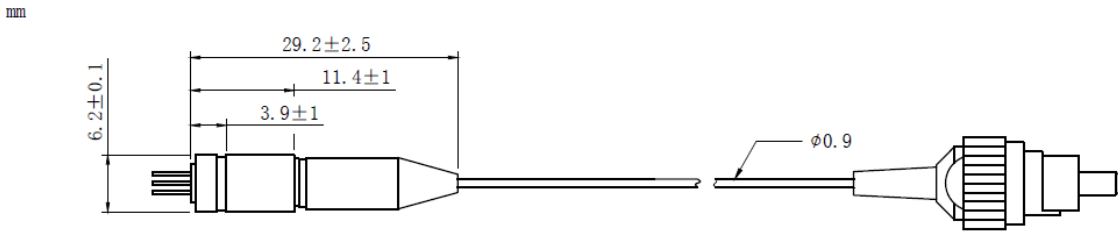

Coaxial Package View: (Part Number: WSLP-685-015m-PM-PD)



B82 Package View: (Part Number: WSLP-685-015m-PM-B-PD)

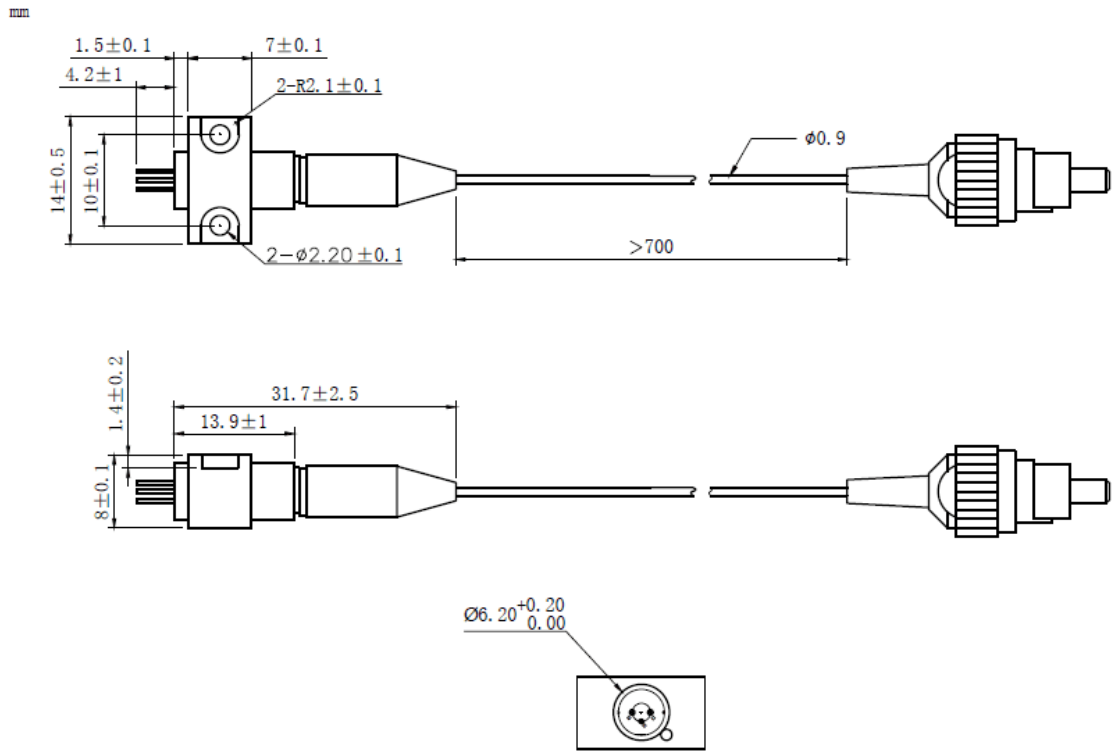

PIN Bottom View:

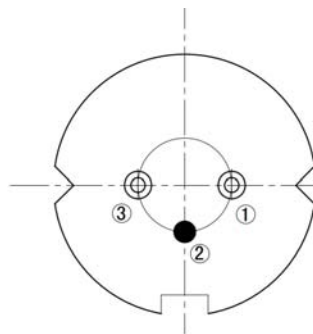

1	LD(-)
2	LD(+)& PD(-)
3	PD(+)



Electrically shorten LD module and store in non-extreme conditions.
Suggest using the constant current power supply.

