

1470nm 3W Laser Diode with H-mount Package | Window Package | Square Beam Optional
1470nm 3W High Power LD | Hermetic Package | Infrared Laser Diode | FAC Optional
 WSLD-1470-003-H Wavespectrum Laser Group www.wavespectrum-laser.com

1470nm Laser Diode	3W/H-mount	Wavespectrum Laser Group	
Reverse Voltage	V_r	2.0	V
Operating Temperature	T_{op}	+10~+30	°C
Storage Temperature	T_{stg}	-20~+80	°C
Lead soldering temperature (10 sec.)	T_{is}	260	°C
Features: <ul style="list-style-type: none"> 1470nm 3W Output Power H-mount Package (Window Package) 			
Applications: <ul style="list-style-type: none"> Medical Laser Treatment Others 			
Specifications		WSLD-1470-003-H	
	Min	Type	Max
Center Wavelength@25°C	+/-10nm	1470nm	+/-30nm
Spectral Width (FWHM)	----	10.0nm	----
Output Power	----	3W	----
Emitter Area	----	100x1μm	----
Beam Divergence	----	10°_⊥ x 30°_{//}	----
Temperature Coefficient of Wavelength	----	0.7nm / °C	----
Slope Efficiency	----	0.32W/A	----
Threshold Current (Typ.)	----	0.5A	----
Operating Current (Typ.)	----	10.0A	----
Operating Voltage	----	2.0V	----
Package Style	H-mount		
Recommended Operating Temperature	25°C		

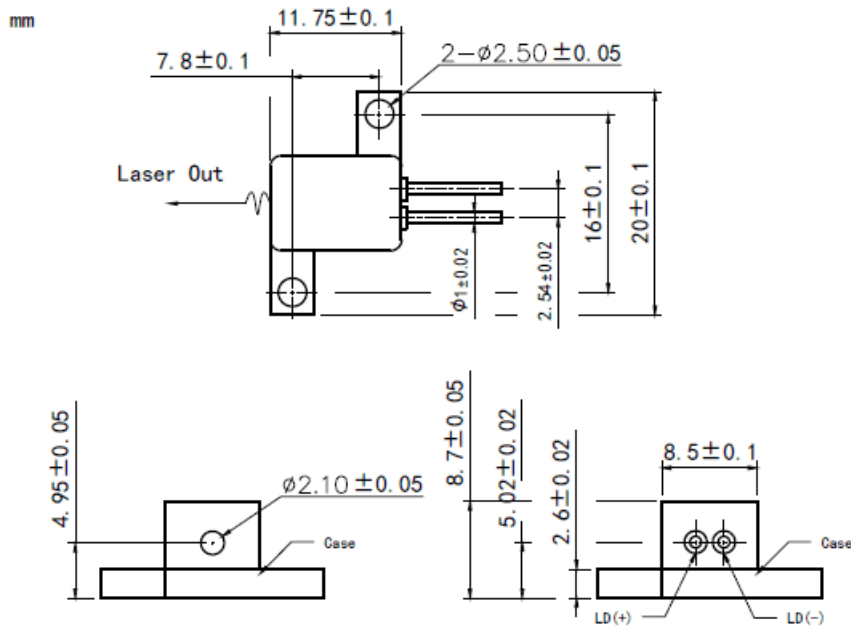

H-mount Package View



**Electrically shorten LD module and store in non-extreme conditions.
Suggest using the constant current power supply.**

