

1310nm~1320nm 1.5W Laser Diode with C-mount Package | FAC Lens Optional | High Power LD
1310nm 1.5W Output Power | Hermetic Package Optional | Square or Line Beam Optional
 WSLD-1310-1500m-C Wavespectrum Laser Group www.wavespectrum-laser.com

1310nm Laser Diode 1.5W/C-mount		Wavespectrum Laser Group	
PARAMETER	SYMBOL	VALUE	UNIT
Reverse Voltage	V_r	2.0	V
Operating Temperature	T_{op}	+10~+30	°C
Storage Temperature	T_{stg}	-20~+80	°C
Lead soldering temperature (10 sec.)	T_{is}	260	°C
Features: <ul style="list-style-type: none"> 1310nm 1.5W Power C-mount Package FAC Lens Optional (Square or Line Beam) 			
Applications: <ul style="list-style-type: none"> Medical Laser Treatment Others 			
Specifications		WSLD-1310-1500m-C	
		Min	Type
Center Wavelength@25°C		+/-10nm	1310nm
Spectral Width (FWHM)		----	6.0nm
Output Power		----	1.5W
Emitter Area		----	85x1µm
Beam Divergence (With FAC Lens)		----	8° _⊥ x 28° _{//}
Temperature Coefficient of Wavelength		----	0.7nm / °C
Slope Efficiency		----	0.5W/A
Threshold Current (Typ.)		----	0.4A
Operating Current (Typ.)		----	3.3A
Operating Voltage		----	1.3V
Package Style		C-mount	
Recommended Operating Temperature		25°C	

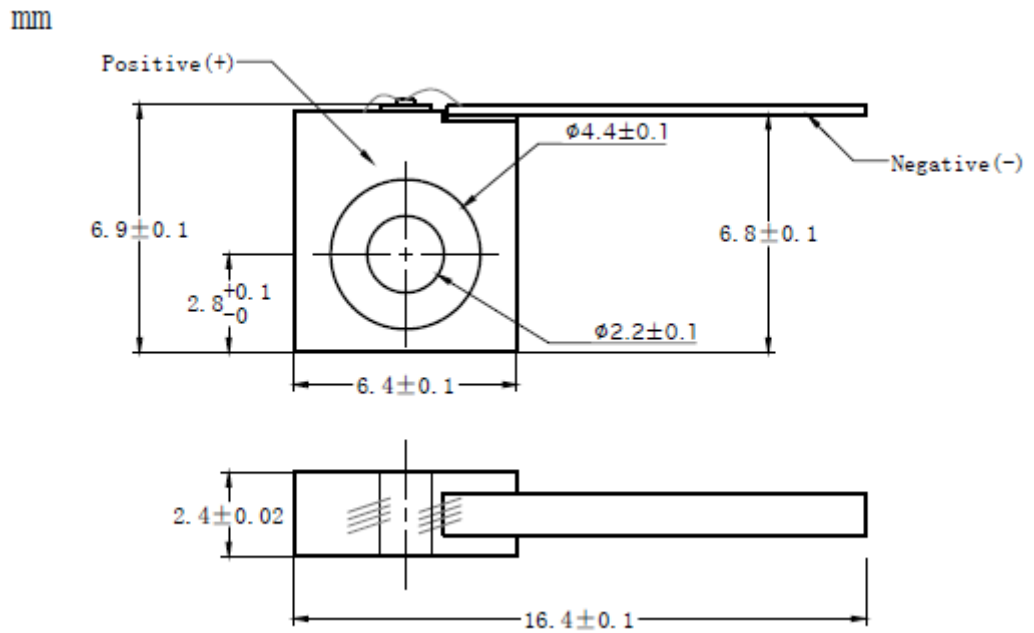

C-mount Package View



**Electrically shorten LD module and store in non-extreme conditions.
 Suggest using the constant current power supply.**

