

976nm~980nm 5W Laser Diodes with TO3 package | Square Beam Optional
980nm 5W High Power LD | FAC Lens Optional | Hermetic Package

WSLD-980-005-3

Wavespectrum laser Group.

www.wavespectrum-laser.com

980nm Laser Diode	5W/TO3	Wavespectrum Laser Group	
Reverse Voltage	V_r	2.0	V
Operating Temperature	T_{op}	+10~+30	°C
Storage Temperature	T_{stg}	-20~ +80	°C
Lead soldering temperature (10 sec.)	T_{is}	260	°C
Features: <ul style="list-style-type: none"> ● 980nm ● High Power ,CW, Multi-mode ● TO3 Package 			
Applications: <ul style="list-style-type: none"> ● Medical Laser Treatment ● Laser Indicator ● Laser Detector 			
Specifications	WSLD-980-005-3		
	Min	Type	Max
Center Wavelength@25°C	+/-5nm	976nm	+/-10nm
Spectral Width (FWHM)	----	3.0nm	----
Output Power	----	5W	----
Emitter Area	----	100x1μm	----
Beam Divergence (FWHM)	----	35°_⊥ x 8°_{//}	----
Temperature Coefficient of Wavelength	----	0.3nm / °C	----
Slope Efficiency	----	1.0W/A	----
Threshold Current (Typ.)	----	0.3A	0.7A
Operating Current (Typ.)	----	5.2A	5.5A
Operating Voltage	----	1.6V	2.2V
Package Style	TO3		
Recommended Operating Temperature	25°C		



T03 Package View

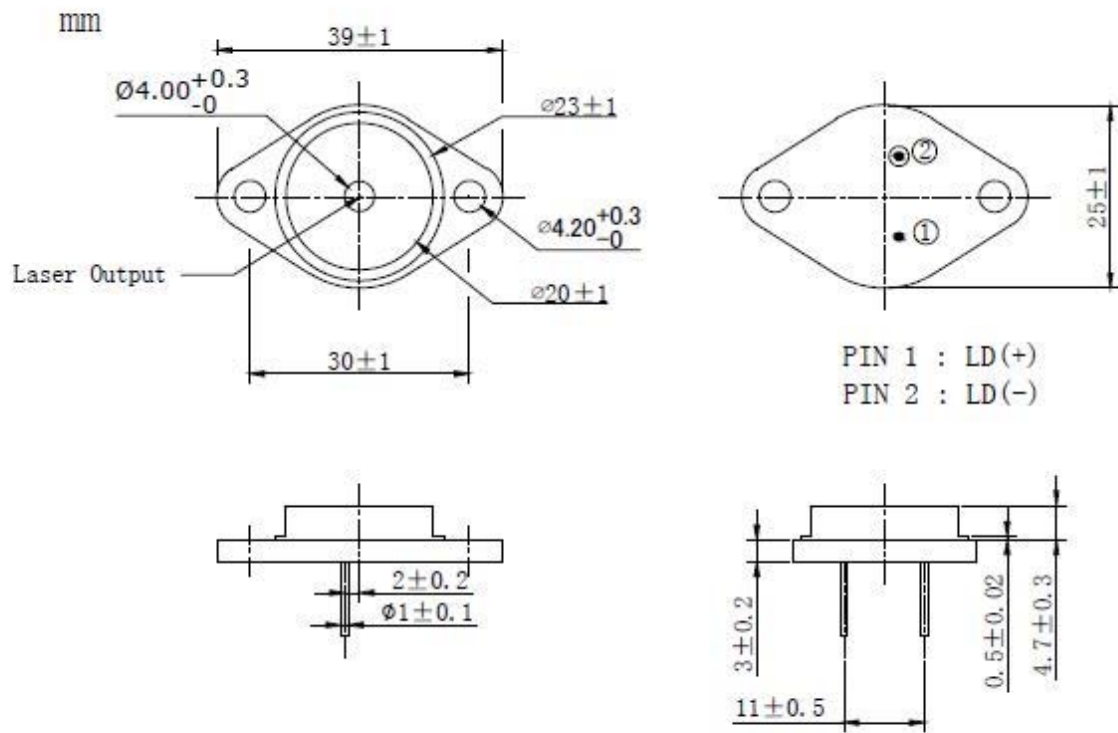

**Electrically shorten LD module and store in non-extreme conditions.
 Suggest using the constant current power supply.**

