

1530nm 2W Laser Diode with TO3 Package with FAC Lens Optional

1530nm 2W Power | High Power LD | TO3 Package | Square or Line Beam Optional

WSLD-1530-002-3

Wavespectrum Laser Group

www.wavespectrum-laser.com

1530nm Laser Diode 2W		Wavespectrum Laser Group		
Reverse Voltage	V_r	2.0	V	
Operating Temperature	T_{op}	+15~+30	°C	
Storage Temperature	T_{stg}	-40 ~ +60	°C	
Lead soldering temperature (10 sec.)	T_{is}	260	°C	
Features: <ul style="list-style-type: none"> 1530nm 2W Power TO3 Package FAC Lens Optional (Square Beam) 				
Applications: <ul style="list-style-type: none"> Medical laser treatment Others 				
Specifications		WSLD-1530-002-3		
		Min	Type	Max
Center Wavelength@25°C		+/-10nm	1530nm	+/-30nm
Spectral Width (FWHM)		----	7.0nm	10.0nm
Output Power		----	2W	----
Emitter Area		----	85x1µm	----
Beam Divergence (With FAC Lens)		----	8° _⊥ x 28° _{//}	----
Temperature Coefficient of Wavelength		----	0.7nm / °C	----
Slope Efficiency		----	0.5W/A	----
Threshold Current (Typ.)		----	0.5A	----
Operating Current (Typ.)		----	5.0A	5.5A
Operating Voltage		----	1.3V	1.5V
Package Style		TO3		



T03 Package View

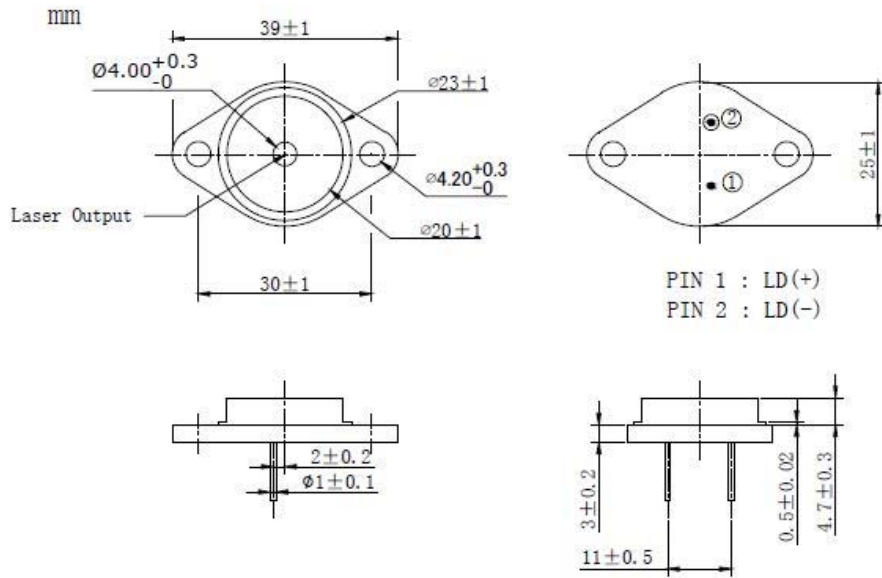

Electrically shorten LD module and store in non-extreme conditions.

Suggest using the constant current power supply.

